

# Pecan Equipment

Lenny Wells

UGA Horticulture



[extension.uga.edu](http://extension.uga.edu) | 1-800-ASK-UGA1

# Equipment Costs (U.S. Dollars)

Item	Cost	Interest (3.5%)	Insurance	TOTAL
Herb. Sprayer	6000	210	4	
Air-blast Sprayer	101,000	3535	546	
Rotary Mower	16,000	560	47	
Dump Wagon	24,000	840	84	
Harvest Wagon	4000	140	14	
Tractor (100 hp)	95,000	3325	340	
Light Tractor (50 hp)	25,000	875	239	
Truck	30,000	1050	50	
Blower	7000	245	31	
Sweeper	15,000	525	84	
Harvester	60,000	2100	269	
Shaker	130,000	4550	798	
TOTAL	513,000	17,955	2507	533,462



# Planting

- Transplanting Nursery Trees
  - Large diameter hole = better root establishment



# Planting

- Transplanting Nursery Trees
  - 18" or larger auger
  - Backhoe



# Transplanting Older Trees





# Tractor Requirements

- Most tasks in a pecan orchard can be accomplished with 100-125 hp tractor



# Tractor Requirements

- Lighter tractor may be used for herbicide application, tree planting, limb removal, etc.





# Mowers

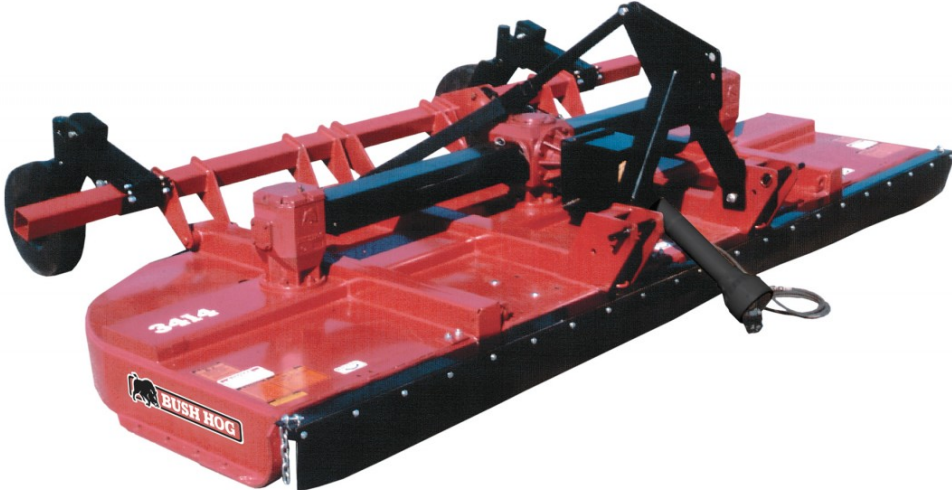

# Herbicide Tanks



[extension.uga.edu](http://extension.uga.edu) | 1-800-ASK-UGA1

# Nozzles

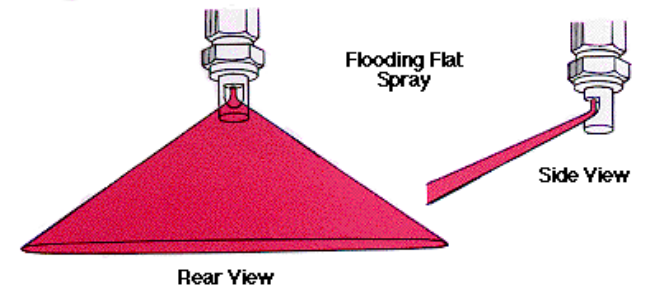
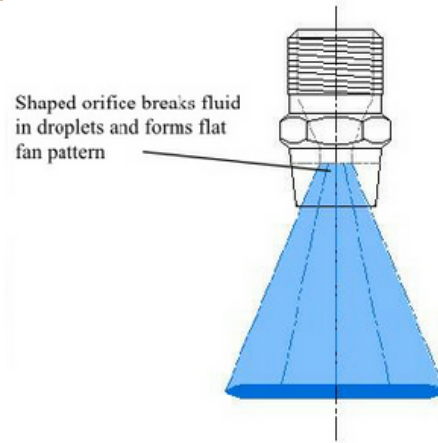
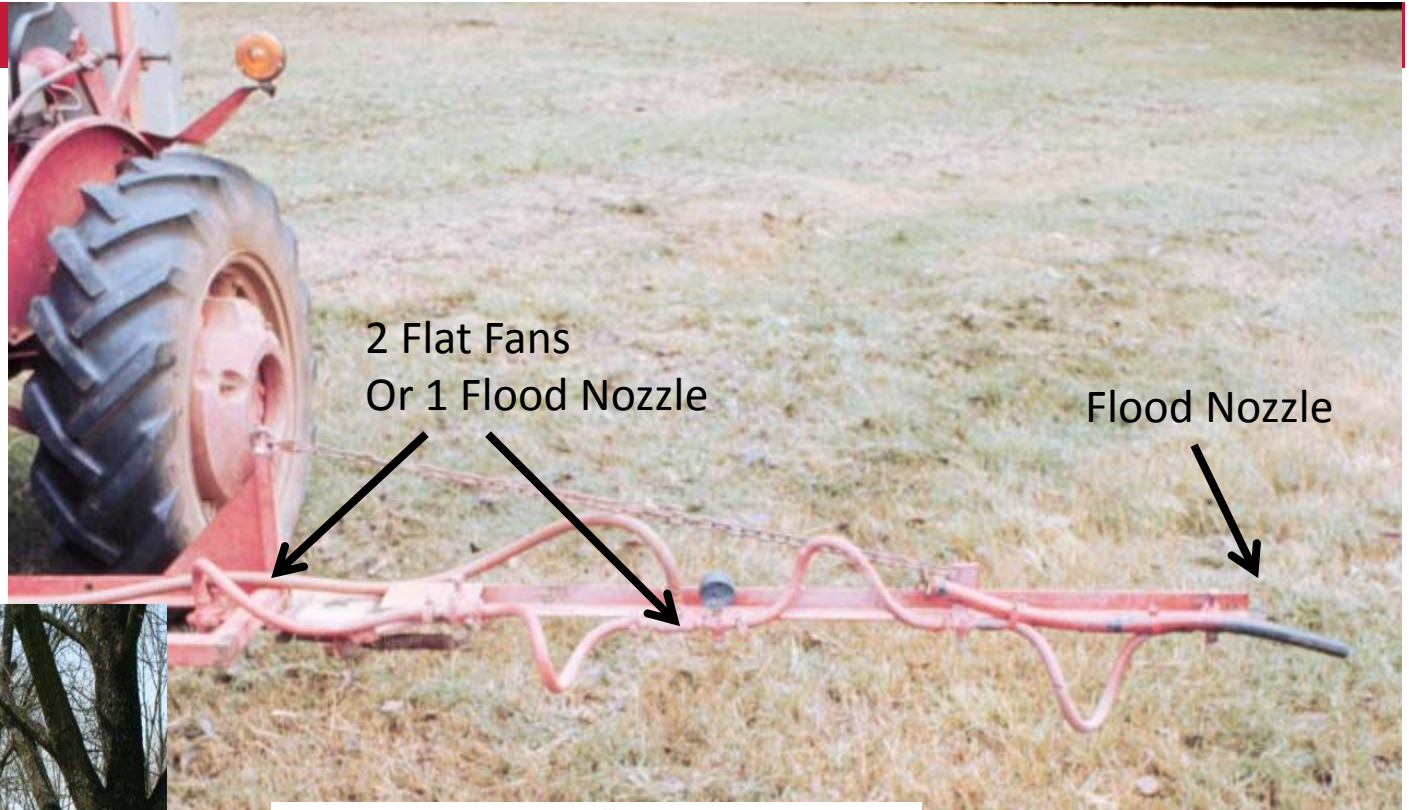

# Air-Blast Sprayers



# Air-Blast Sprayers

Table 1. Recommended total spray volume of application for pecan.

Tree Height (feet)	Total Volume (Gallons per Acre)
Up to 25	25
25 to 50	50 to 90
50 and Up	100 to 150



# Air-Blast Sprayers

$\frac{2}{3}$  -  $\frac{3}{4}$  Spray Directed Toward Top  $\frac{1}{2}$  of Tree  
 $\frac{1}{4}$  -  $\frac{1}{3}$  Spray Directed Toward Bottom  $\frac{1}{2}$  of Tree

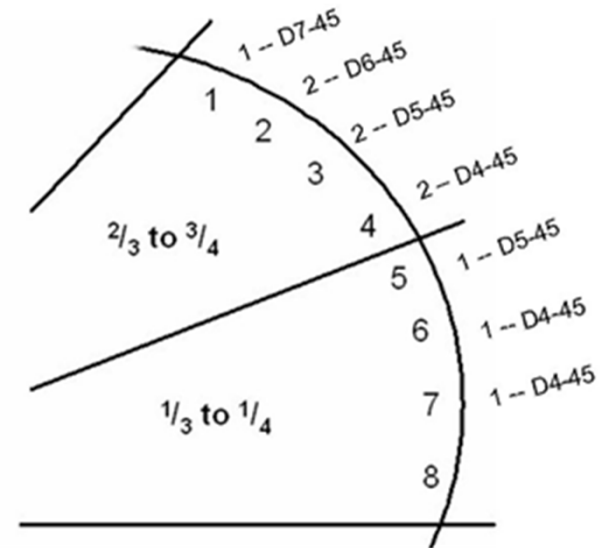
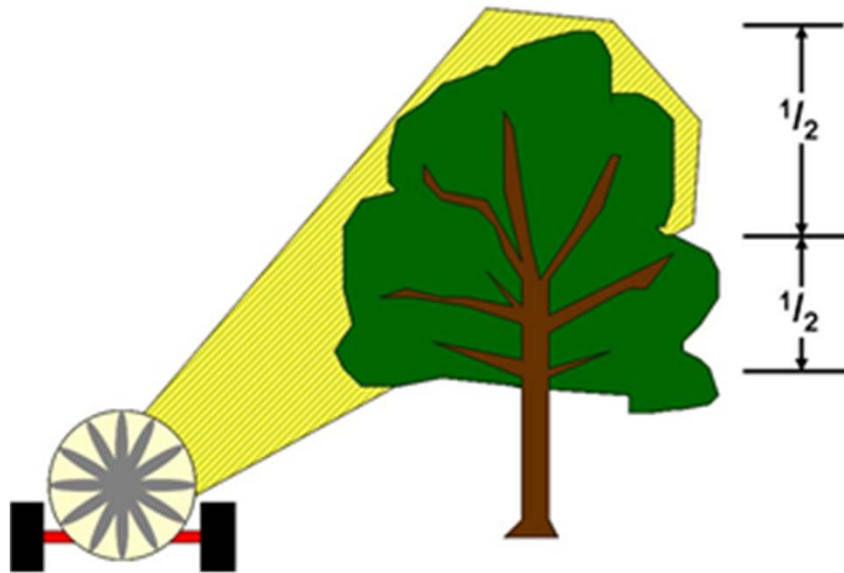

Without Volute

# Coverage

With Volute



# Shakers





# Harvesting Systems



# Sweepers

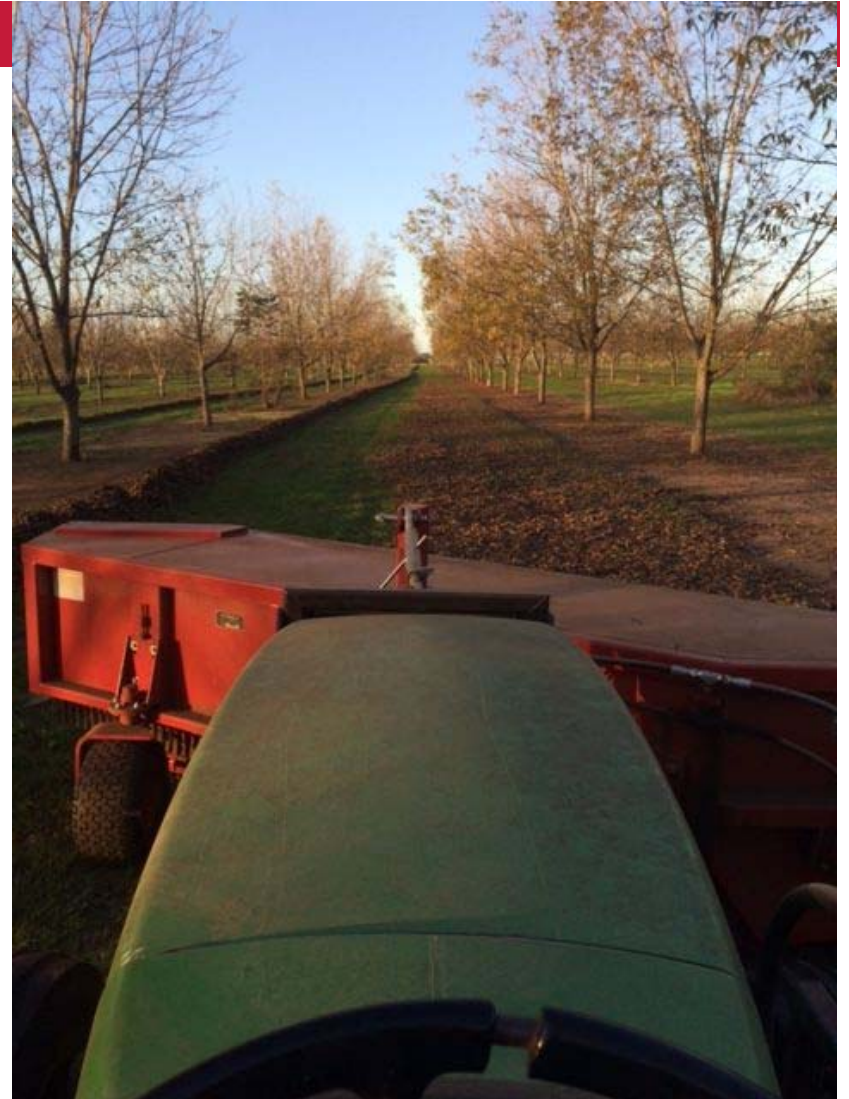

K-UGA1

# Blower



# V-Sweeper



# Harvesters



# Harvesters



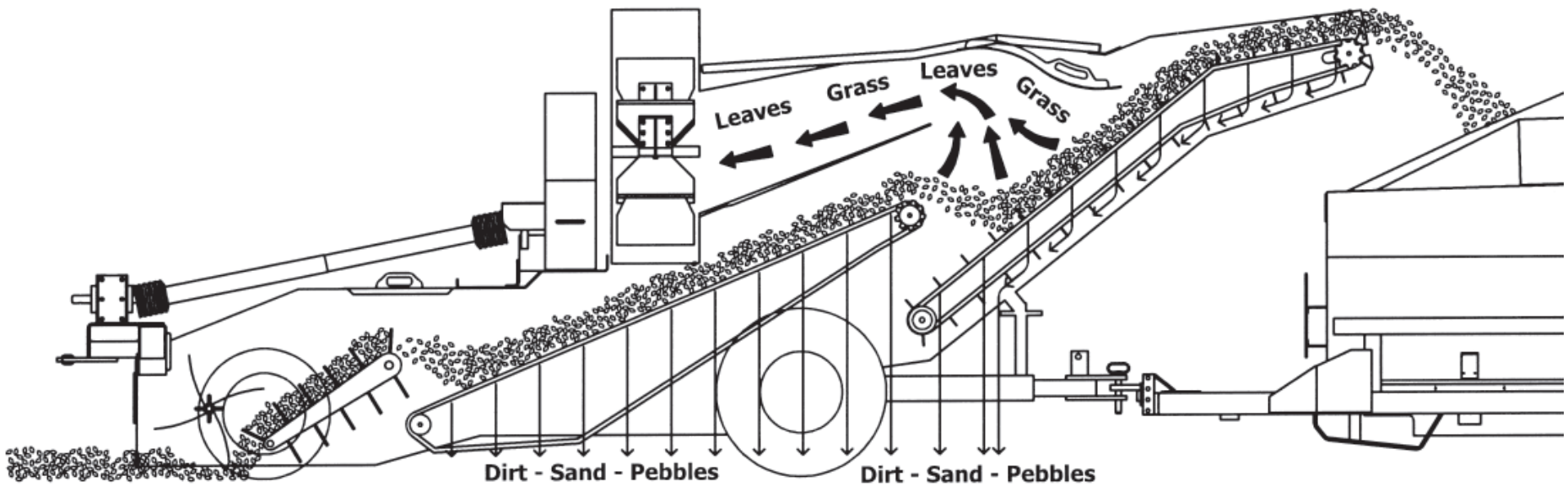





# Dump Cart With De-Sticker



# Harvesters



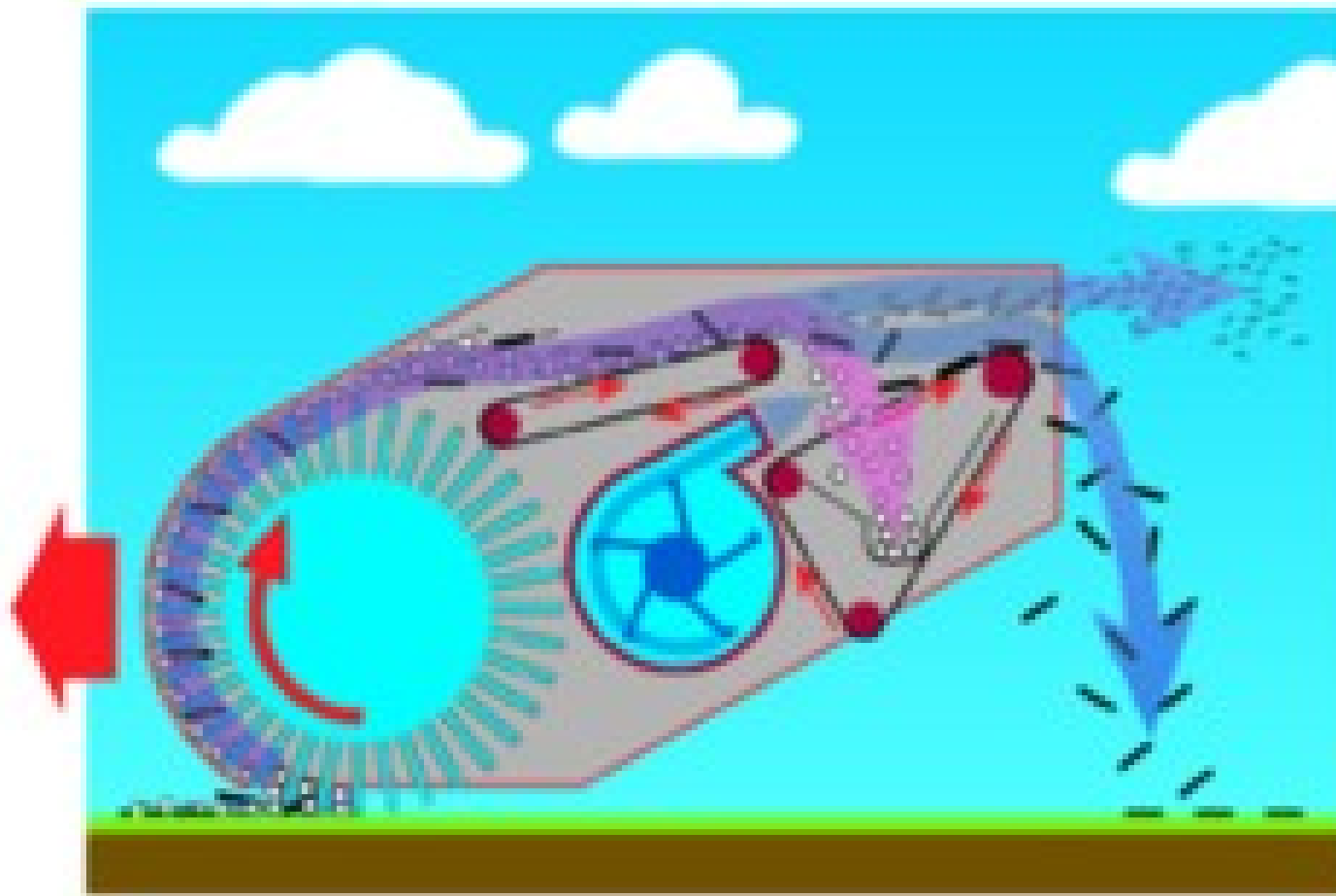



[extension.uga.edu](http://extension.uga.edu) | 1-800-ASK-UGA1



# Cleaner



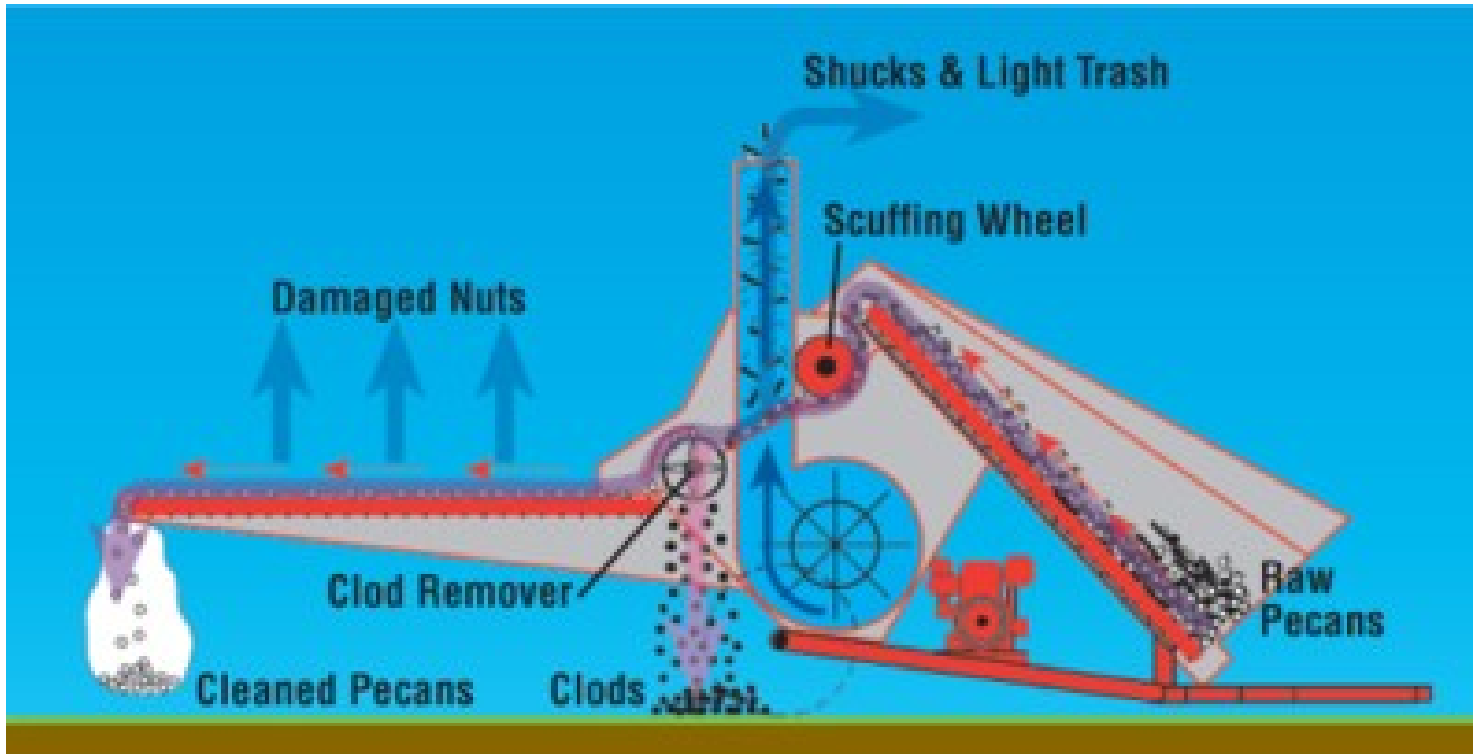

# Hedgers





[extension.uga.edu](http://extension.uga.edu)

1-800-ASK-UGA1





[extension.uga.edu](http://extension.uga.edu)

1-800-ASK-UGA1

Questions?

